

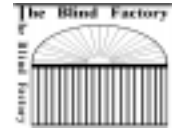

Mounting Instructions

Perfecta Cellular Shades & Pleated Shades - standard draw system



The Blind Factory * 5277 S. Florida Ave. * Lakeland, FL 33813 * (863) 646-8891 * (800) 662-3955 * Fax (863) 701-0889

Congratulations. You have purchased a FineCraft Cellular Shade / TBF Pleated Shade, the worlds finest name in custom blinds, shades & shutters. Be sure to ask for genuine FineCraft products whenever needed. Please carefully read the instructions below and fill out and mail the enclosed registration / warranty card. After installation, you will begin enjoying years of service from your FineCraft products. If you have any further questions, please contact your authorized FineCraft dealer.

You will need: A steel tape measure, power drill or screwdriver, #2 square Robertson driver bit, pencil, drill bit.

Step 1) Carefully unpack the FineCraft Shade from the protective packaging being cautious not to cut any of the shade cords or damage the shade.

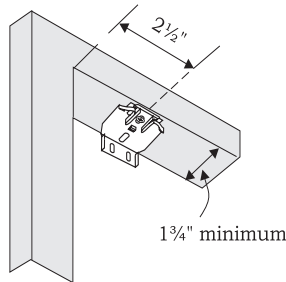

Step 2) For inside mount configurations: Mark a line no less than 2 1/2" from both window jambs as shown. Using only the supplied screws, install a screw through the shallow mount holes and into the window header through the marked line. For shades over 70" wide, install an additional bracket in the center of the window in line with the left and right brackets. Inside mount shades have a 1/2" width deduction taken off at the factory to allow proper shade operation.

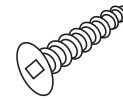

Shallow
Mount
back hole

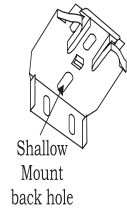
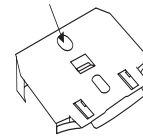

Shallow
Mount
back hole

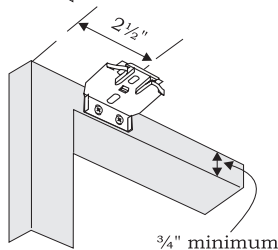

Step 2) For outside mount configurations: Mark a line no less than 2 1/2" from both window jambs as shown. Using only the supplied screws, install screws through the back bracket holes and into the window header or trim as shown. For shades over 70" wide, install an additional bracket in the center of the window in perfect alignment with the left and right brackets. Outside mount shades are made at the exact ordered width. Please note that the bottom end caps add 1/8" to the width of the bottom rail.

Step 3) With the headrail tipped as shown, insert the spring loaded bracket tip into the corresponding headrail lip as shown. While applying pressure on the headrail, rotate the rear of the headrail upwards so that the rear bracket tip catches in the corresponding headrail lip as shown. Center the shade in / on the opening. Removal of the blind is the reverse of the above.

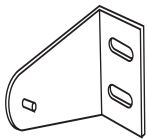
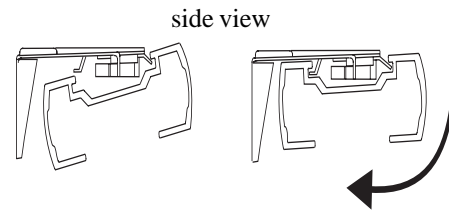

hold-down
bracket

For blinds with optionally ordered hold-down brackets, install the bracket to the wall / door surface in alignment with the outside ends of the bottom rail. Insert the hold-down pin in the ends of the bottom rail end plug as shown. If needed, drill a hole into the center of the bottom rail end plug to receive the bracket pin as shown.

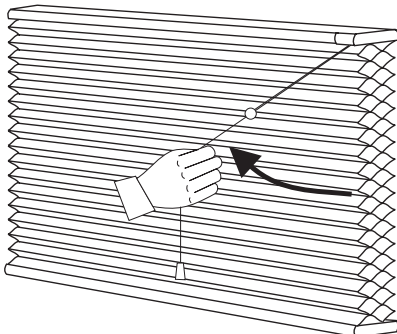
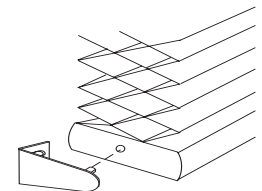

You're done! Operate the cord lock to let down the shade as shown. On some shades, the fabric must be allowed to relax for a period of time to allow the shade to lower completely. FineCraft Blinds are built to give years of enjoyment! For safety, be sure to keep any cords out of the reach of children and pets using a cord clip or cord tie down brackets. FineCraft Blinds should be kept clean and dusted to maintain the quality factory finish. If you have any questions, please contact your authorized FineCraft dealer.

